

BoscoLighting's CLK Trimless Downlight is designed to be plastered into ceilings, perfect for high-end residential or commercial projects.

Once installed, it creates a true 100% seamless and sleek finish.

Features

- LED Driver Included
- Supplied with Flex & Plug
- Reflector option: White, Black, Matte Silver, Gloss Silver, Bronze, Champagne Gold

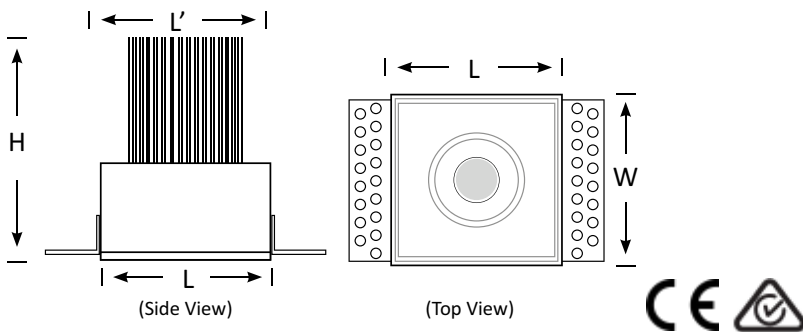

Product Code	BLDL-CLK-10
Power (W)	10
Luminous Flux(lm)	850
CCT	Warm White, Neutral White, Cool White (3000K-6500K)
Connect	AU Standard Flex & Plug
Dimming Options	Various dimming options available on request
Dimensions(mm)	L84*W75*H115
Cutout(mm)	L'85*W'76
Weight(kg)	0.3

Downlight CLK

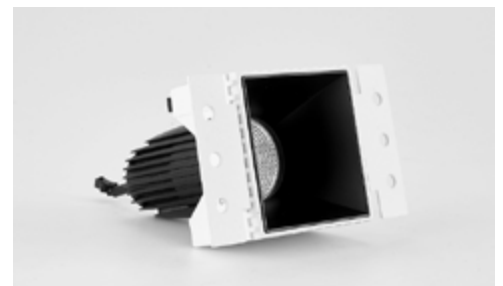

Installation Instructions:

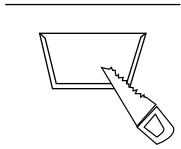

1. Cut hole in plaster to required cutout size

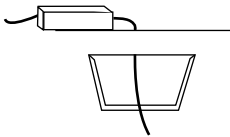

2. Connect the power and place the driver into the cavity.

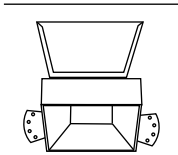

3. Place the mounted frame

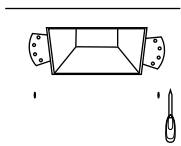

4. Secure by using drywall screws*
*Screws not included
(holes size: D 0.66mm)

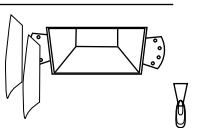

5. Patch over frame with stucco or plaster and paint per ceiling colour.

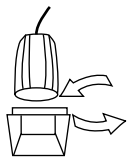
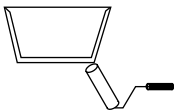

6. Click and twist the light into the reflector

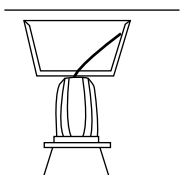

7. Align notches in reflector with mounting frame and push upwards. Will click into place.

To remove, push upwards to release spring.

BLDL-CLK-10

This product comes complete with a mounted frame, a reflector, a 10W LED light, a driver and Flex&Plug.

